

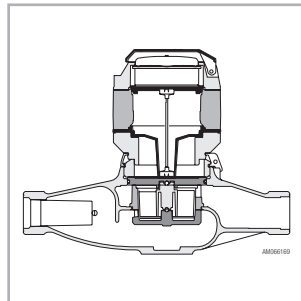

DOMINO®

Flow meters for chemical liquids
DN 15...50

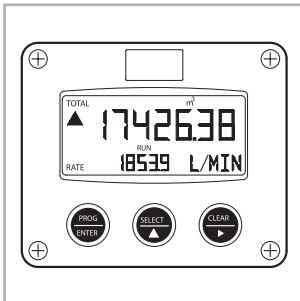
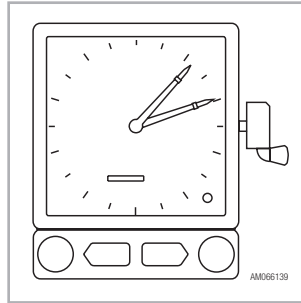
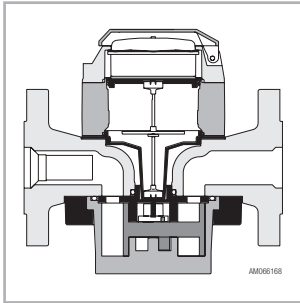

Flow measurement of liquids in chemical, pharmaceutical, cosmetic and other industries. Batching and filling operations.

Features

- Product versions for safe areas or for hazardous areas (ATEX)
- Modular products with wide range of flow sensors, displays, pulsers and batching controls
- Mechanical, pneumatic and electronic batching controls

Benefits

- Highly flexible mounting with least space requirements
- Suitable for both conductive and non conductive liquids
- Flow disturbances do not influence proper operation and accuracy
- Long life with low maintenance

DOMINO® - the modular flow measurement concept

System overview

Page 4

ARD rotary piston flowmeters for 15...30.000 l/h



- Nominal diameter DN 15, 20, 25, 40 and 50 mm
- Operating pressures PN 10, 16, 25 or 40
- Fluid temperatures up to 180 °C
- Modular meter concept in various materials
- Measuring error limits $\pm 0,5$ % of effective value
- For high viscosity range up to about 10.000 mPa·s
- Swivelling roller register for optimal readability
- Special-purpose calibrations for differential measurement (optional)
- All flowmeters available with various modules according to need

Page 8

AMD vane wheel flowmeters for 140...12.000 l/h



- Nominal diameter DN 25 and 40 with flanged connections
- Operating pressure PN 25
- Fluid temperatures up to 90 °C, special versions up to 180 °C
- For low viscosity range up to 4 mPa·s
- Measuring error limits 2 % of effective value
(± 5 % at lower end of measuring range)
- All flowmeters available with various modules according to need

Page 13

PMD vane wheel flowmeters for 100...20.000 l/h



- Nominal diameter DN 20, 25 and 40 with threaded connections
- Operating pressure PN 16
- Fluid temperatures up to 90 °C
- Primarily for water, also for non-aggressive low-viscosity fluids up to 4 mPa·s
- Measuring error limits ± 2 % of effective value
(± 5 % at lower end of measuring range)
- All flowmeters available with various modules according to need

Page 16

Pulsers

Page 18

Ordering information

Page 19

Accreditations

Page 24

System overview

Meter Ancillaries

- display in volumetric units (litre or m³)
- with pulser, roller counter or for batching devices

RW

- Roller register
- local totalization

RV

- Roller register with integral reed-type pulser
- local totalizing
 - pulser for remote totalizing
 - not for use in hazardous areas!

IN

- Inductive pulser for industrial control systems
- to IEC 60947-5-6
 - 2 different resolutions
 - for hazardous location Zone 1 (ATEX version)
 - roller register

INA

- Inductive pulser for industrial control systems
- to IEC 60947-5-6
 - high resolution for analogue signal generation or input to electronic batching controls
 - for hazardous location Zone 1 (ATEX version)
 - optional roller register

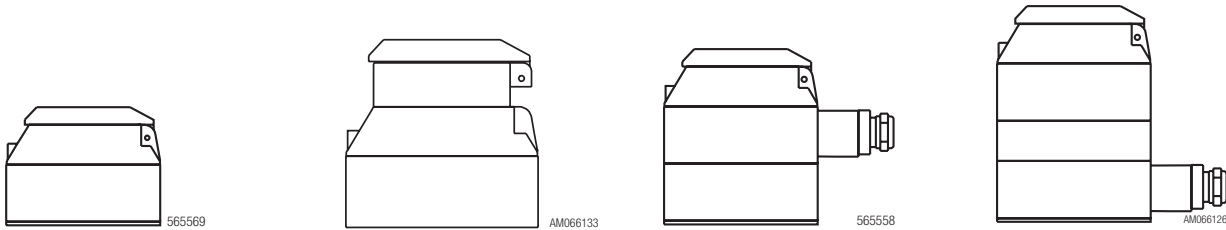

Measuring Units

- different measuring principles (ARD, AMD and PMD)
- various materials according to the meter type (stainless steel, cast iron, brass, PTFE plastics)
- flanges according to DIN (in general also available with ANSI or JIS borings)

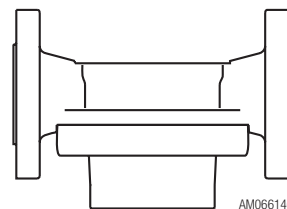

ARD Rotary Piston Meters for chemical liquids

Nominal diameter	15, 20, 25, 40, 50 mm
Nominal pressure	10, 16, 25, 40 bar
Temperature	40, 50, 90, 130, 180 °C
Flow rate	10 - 30'000 l/h

Accessories

- batching devices for manual, semi-automatic and automatic control

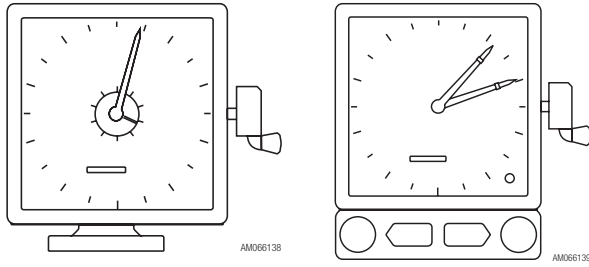

GTAS module
Intermediate drive for AS or ASP batching control

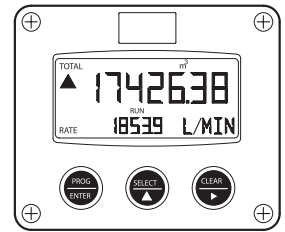

MS-KP
Mounting set for compact mounting F131

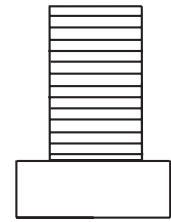

INA module
Pulsar for electrical batching units

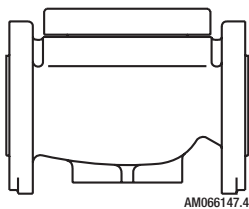
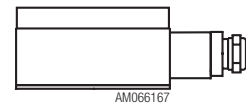
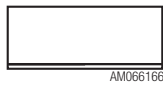

AMD Vane Wheel Meters for chemical liquids

Nominal diameter	25, 40 mm
Nominal pressure	16, 25 bar
Temperature	90, 180 °C
Flow rate	140 - 12'000 l/h

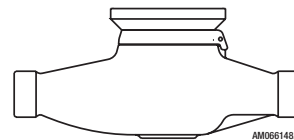

PMD Vane Wheel Meters for cold and hot water / batching

Nominal diameter	20, 25, 40 mm
Nominal pressure	16 bar
Temperature	90 °C
Flow rate	100 - 20'000 l/h

Applications

- ARD rotary piston flowmeters for pure chemical liquids of various types
- AMD vane wheel flowmeters for chemical liquids
- PMD vane wheel flowmeters for water (in particular for dosing)

Selection of commonly measured liquids

Actic acid

Acetone

Animal fats

Ammonium hydroxide, ammonia solution

Bromine hydroxide, bromic acid

Butyl acetate, acetic butyl ester

Chloroform, trichloromethane

Citric acid

Diethylene glycol

Distilled water

Ethyl acetate, acetic ether, acetic ester

Ethyl alcohol, alcohol, ethanol

Ethyl ethylene, ethylene, diethyl ethylene

Ethylene glycol

Formaldehyde solution

Formic acid

Glycerine

Hexane

Hydrochloric acid

Hydrofluoric acid

Hydrogen peroxide, hydrogen superoxide

Isopropyl ether, di-isopropyl ether

Isopropyl alcohol, propyl alcohol

Kerosine, petroleum

Liquid ammonia

Liquid bromine

Liquid butane

Magnesium sulphate

Methanol, methyl alcohol

Methylene chloride, dichloromethylene

Methyl ethyl ketone

Molasses (without urea)

Nitric acid

Paraffin

Perchloroethylene, tetrachloroethylene

Phosphoric acid

Potassium hydroxide, caustic potash

Propionic acid

Prussic acid

Pure benzol

Sodium chloride solution, brine

Sodium hydroxide, caustic soda solution

Sodium hypochlorite solution, Javelle water

Sulfocarbonic acid

Sulphuric acid

Tar, pitch

Tetrachloromethane, carbon tetrachloride

Toluene

Trichloroethylene (dry)

Vegetable oils

Operation principles

ARD range

- Works on the volumetric principle with rotary pistons
- Wide measuring range with high precision
- Suitable for high viscosities
- Insensitive to flow disturbances
- No power supply needed

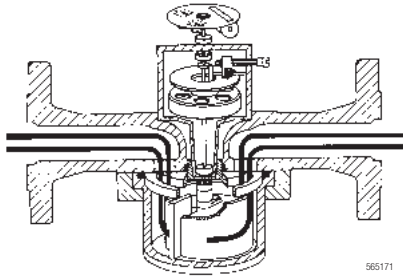

AMD and PMD series

- Works on the velocity measuring principle with multi-jet vane wheel
- Extremely wide measuring range with good accuracy
- Largely insensitive to slight impurities in liquid media
- Insensitive to flow disturbances
- No power supply needed

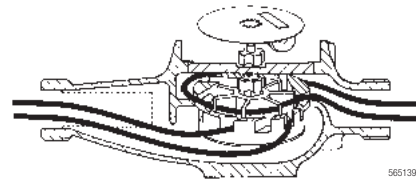

Design features

ARD range

- The only moving parts in contact with the liquid medium are the rotary piston, guide rollers and carrier. The hydraulic measuring module is completely isolated from the roller register, and signals are transmitted magnetically through the sealed cover of the measuring chamber.
- For optimal readability, the roller register can be swivelled through 360° on versions without RV integral pulser.

AMD and PMD series

- The only moving part in contact with the liquid medium is the vane-wheel. In AMD models this is mounted between PTFE bearings, and in PMD models on ruby bearings. This ensures years of easy running and high precision, long life and excellent long-term stability of the measuring characteristic.
- The hydraulic measuring module is completely isolated from the rollerregister, and signals are transmitted magnetically through the sealed cover of the measuring chamber.
- For optimal readability, the roller register can be swivelled through 360° on versions without RV integral pulser.

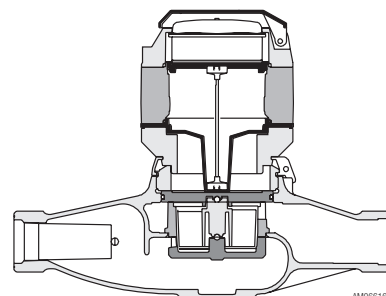
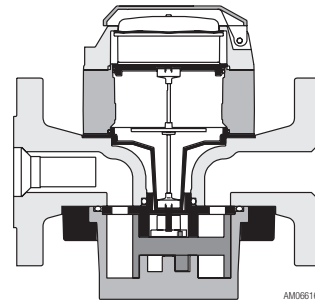

DOMINO® ARD rotary piston flowmeters

Technical data



- For chemical liquids with viscosities up to about 10 000 mPa·s
- For horizontal or vertical installation
- Measuring error limits ± 0.5 % of effective value, repeatability ± 0.1 %
Max. temperature 40, 50, 90, 130 or 180 °C (according to version)
- Max. pressure 10, 16, 25 or 40 bar (according to version)
- Threaded connections (brass housing) up to DN 40 mm
- Flanged connections DIN 2501 / SN 21843 (cast iron, brass, PTFE plastics housing)
- Combinable with all DOMINO® modules
- Special versions or different flange-standards on request

Nominal diameter	DN	mm	15	20	25	40	50
		inch	1/2	3/4	1	1 1/2	2
Overall length		mm	165	165	190 ¹⁾	300	350
Rated max. pressure with threaded connections							
ARD 1000		bar	16	16	16	16	16
Rated max. pressure with flanged connections							
ARD 1000		bar	25	25	25	25	25
ARD 2000		bar	40	40	40	40	40
ARD 3000		bar	25	25	25	25	25
ARD 4000		bar	10	10	10	10	10
Maximum flow rate ²⁾	Q _{max}	l/h	400	1500	3000	9000	30000
Flow in batching mode	Q _{ch}	l/h	320	1200	2400	7200	24000
Continuous flow rate ²⁾	Q_n	l/h	200	750	1500	4500	15000
Minimal flow rate ³⁾	Q _{min}	l/h	30	60	150	450	1500
Starting flow rate approx. ³⁾		l/h	6	12	30	90	300
Smallest registered value ⁴⁾		l	0.01	0.1	0.1	0.1	1
Metering capacity ⁴⁾		m ³ /h	1000	10000	10000	10000	100000
Metering time at Q _n without overflow ⁴⁾		h	5000	13333	6666	2222	6666
Safety filter mesh size		mm	0.4	0.4	0.4	0.8	0.8
Dirt trap filter mesh size		mm	0.1	0.1	0.25	0.25	0.25
Measuring chamber volume		cm ³	12	36	100	330	1200
Housing finish			enamelled yellow RAL 1007				

1) Overall length with PTFE housing is 260 mm.

2) Flowrates for heating oil are higher. For particular data see Technical Documentation CONTOIL® oil flowmeter.

3) Q_{min} and starting flowrates are valid for material combination: brass housing / aluminium pistons for EL heating oil. Q_{min} for other material combination see table below:
„Measuring range as a function of material combination“.

4) For roller register.

Measuring range as a function of material combination

Q_{min} in % of Q_{max} with measuring error limits ± 0.5 %.

Type	Measuring chamber	Rotary piston			
		Aluminium	Graphite	Stainless steel	PTFE
ARD 1000	Brass	5 %	5 %	-	10 %
ARD 2000	Stainless steel	5 %	5 %	10 %	10 %
ARD 3000	Stainless steel	5 %	5 %	10 %	10 %
ARD 4000	PTFE	-	-	-	10 %

Measuring sensors and materials

Type	Component	Material
ARD 1000	Housing	Brass (threaded connections) or spherulitic cast iron (threaded or flanged connections)
	Measuring chamber	Brass / PPS (130 °C) or brass / PTFE (180 °C)
	Seals	FPM (fluoroelastomer)
	Rotary pistons	Aluminium, graphite or PTFE
ARD 2000	Housing	Spherulitic cast iron
	Measuring chamber	Stainless steel* / PPS (130 °C) or stainless steel* / PTFE (180 °C)
	Seals	FPM or PTFE (fluoroelastomer or polytetrafluoroethylene)
	Rotary pistons	graphite, stainless steel* or PTFE
ARD 3000	Housing	Stainless steel*
	Measuring chamber	Stainless steel* / PTFE
	Seals	FPM or PTFE (fluoroelastomer or polytetrafluoroethylene)
	Rotary pistons	graphite, stainless steel* or PTFE
ARD 4000	Housing	PTFE with metal sleeving
	Measuring chamber	PTFE / Tantal with metal sleeving
	Seals	FFKM (Perfluoroelastomer)
	Rotary pistons	PTFE

* Corrosion and acid-resistant steel (CrNiMo) to DIN 1.4408 / 1.4435 / 1.4404

Pressure drop curves

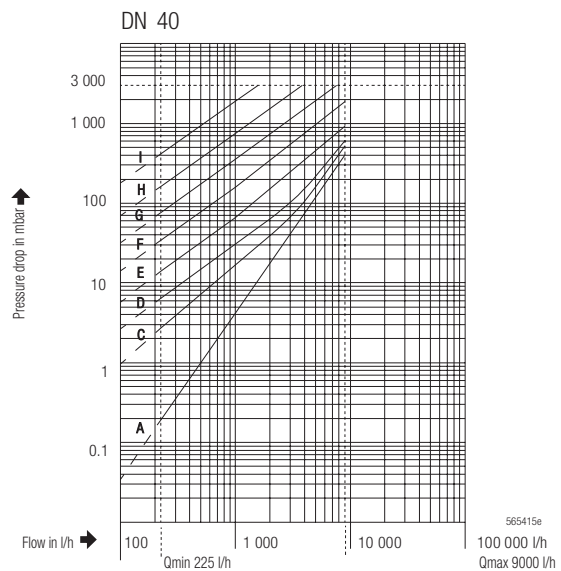
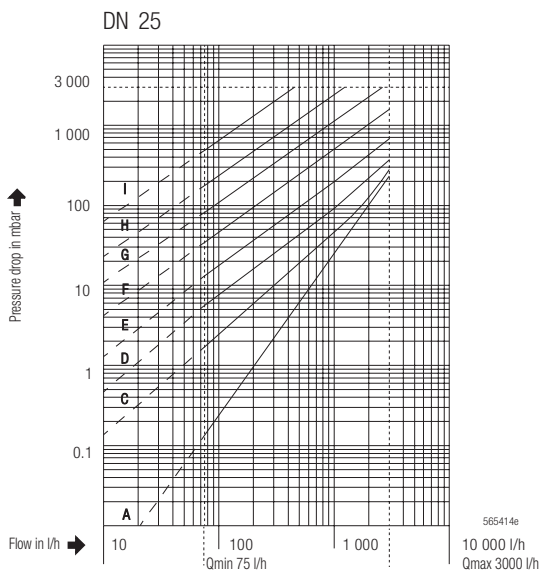
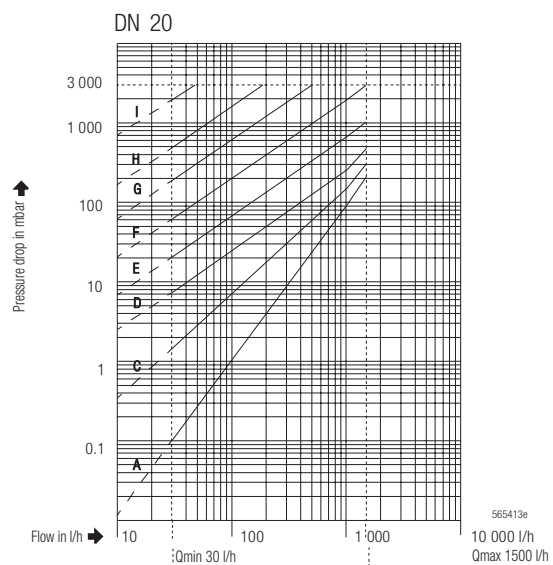
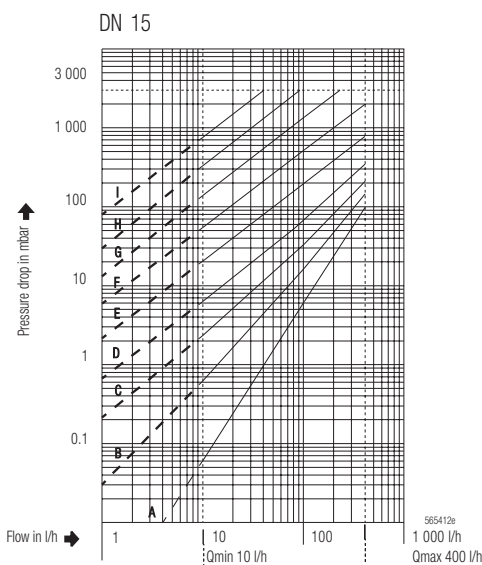

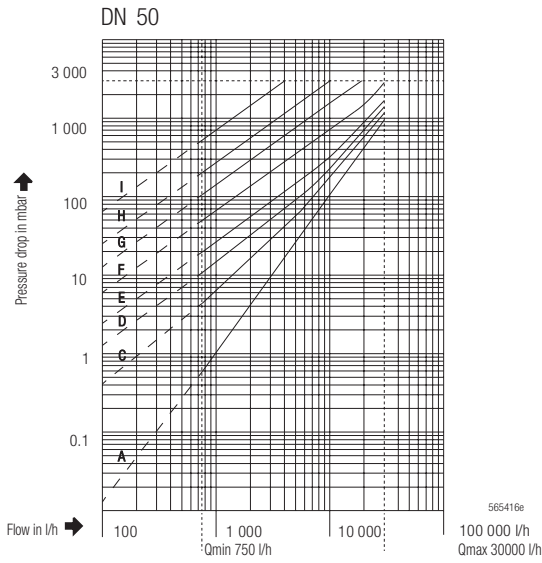

Recommended pressure drop max. 1 bar
Admissible pressure drop max. 3 bar

Viscosities:

- A = 4.5 mPa·s
- B = 25 mPa·s
- C = 50 mPa·s
- D = 100 mPa·s
- E = 200 mPa·s
- F = 500 mPa·s
- G = 1000 mPa·s
- H = 2000 mPa·s
- I = 5000 mPa·s

Flowmeter unit dimensions in mm

ARD 1000 with threaded connections

DN 15, 20, 25

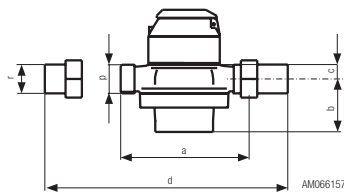
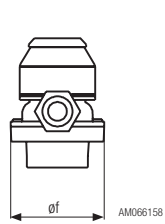

DN 40, 50

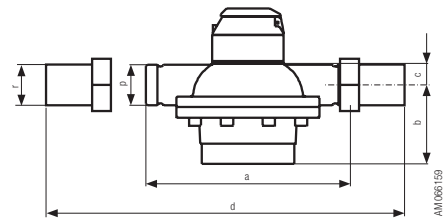
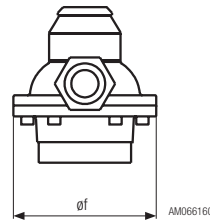

ARD 1000, 2000, 3000 with flanged connections (to DIN 2501)

DN 15, 20, 25

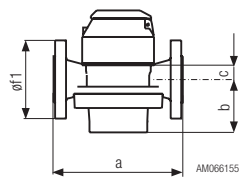
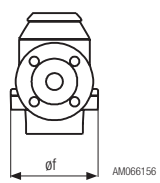

DN 40, 50

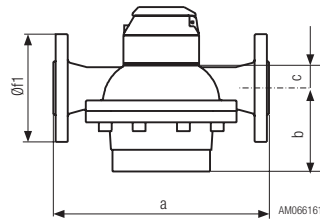
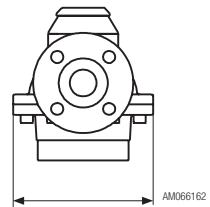

	DN	a	b	c	d	Øf	Øf1	p	r
ARD 15	15	165	42	17	260	105	95	G 3/4"	G 1/2"
ARD 20	20	165	54	17	260	105	105	G 1"	G 3/4"
ARD 25	25	190	78	21	305	130	115	G 1 1/4"	G 1"
ARD 40	40	300	116	32	440	210	150	G 2"	G 1 1/2"
ARD 50	50	350	166	38	510	280	165	G 2 3/8"	G 2"

ARD 4000 with flanged connections (to DIN 2501 / SN 21843)

DN 25

DN 40

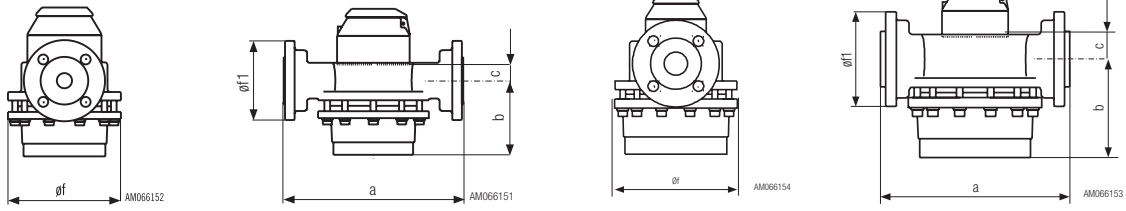

	DN	a	b	c	$\varnothing f$	$\varnothing f1$
ARD 25	25	260	107	23	160	115
ARD 40	40	300	157	35	212	150

Roller registers and dials

RW
roller register only
max. 180 °C

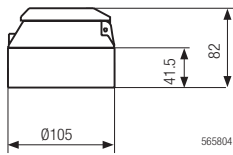

RV
with integrated pulser (reed type)
max. 180 °C

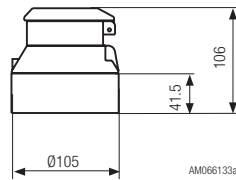

Dials
DN 15

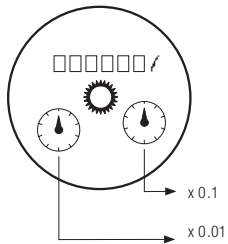

DN 20, 25, 40

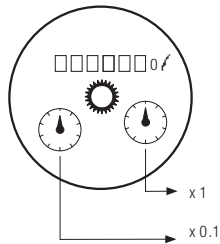

DN 50

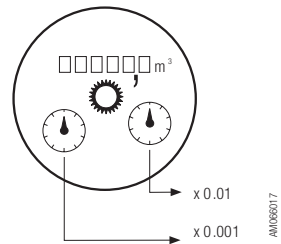

Pulsers

Technical data

For further technical data and wiring diagrammes, see sections „Pulsers“ (page 20) and “Remote pulse transmission” (page 22).

Pulse values

Pulser type	Nominal diameter of measuring unit					
	mm	15	20	25	40	50
	inch	1/2	3/4	1	1 1/2	2
IN Inductive switch (NAMUR)	l/pulse	0.01	0.01	0.1	0.1	1
IN Inductive switch (NAMUR) ¹⁾	l/pulse	0.1	0.1	1	1	10
INA Inductive switch (NAMUR) ^{1) 2)} approx.	l/pulse	0.0006	0.00185	0.005	0.017	0.06
RV Reed switch	l/pulse	0.1	1	1	1	10
	l/pulse	1	10	10	10	100

1) High temperature versions are designated with H.

2) The exact pulse value is indicated on the meter. Since this value is not known before calibration, the connected unit must have an adaptable input. Versions with 2 pulsers on request.

Pulse frequencies

IN at Qmax	Hz	11.111	41.667	8.333	25.000	8.333
IN at Qmin	Hz	0.278	0.833	0.208	0.625	0.208
INA at Qmax	Hz	185.185	225.225	166.667	147.059	138.889
INA at Qmin	Hz	4.630	4.505	4.167	3.676	3.472

IN / INH

Inductive pulser according to IEC 60947-5-6 (NAMUR) with roller register.

IN
max. 130 °C

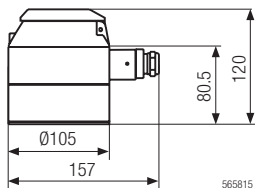

INH
max. 180 °C

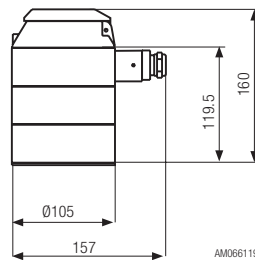

INA / INAH

Inductive pulser according to IEC 60947-5-6 (NAMUR) with high resolution.

INA
without RW (roller register)
max. 90 °C

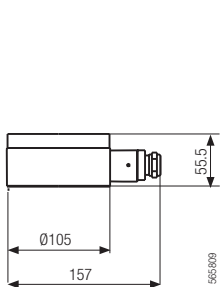

INAH
without RW (roller register)
max. 180 °C

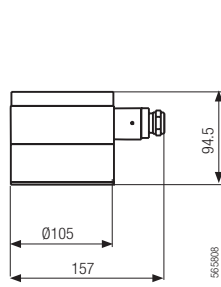

INA-RW
with RW (roller register)
max. 90 °C

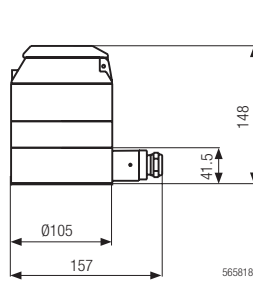

INAH-RW
with RW (roller register)
max. 180 °C

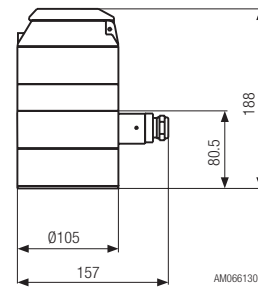

DOMINO® AMD vane wheel flowmeters

Technical data



- For chemical liquids with viscosities up to about 4 mPa·s
- For horizontal installation - dial upward
- Measuring error limits $\pm 2\%$ of effective value ¹⁾, repeatability $\pm 0.3\%$
- Temperature 90 °C, 180 °C
- Rated pressure PN 25
- Housing with flanged connections to DIN 2501 / SN 218643
- Combinable with all DOMINO® modules
- Special versions with other flange holes on request

Nominal diameter	DN	mm	25	40
		inch	1	1 1/2
Overall length		mm	165	300
Rated pressure PN		bar	25	25
Max. temperature	T _{max}	°C	90 resp. 180	90 resp. 180
Maximum flow rate	Q _{max}	l/h	5000	12000
Continuous flow rate	Q_n	l/h	3500	10000
Transitional flow rate	Q _t	l/h	280	800
Minimal flow rate	Q _{min}	l/h	140	400
With AS 110 filling control:				
Transitional flow rate	Q _t	l/h	350	1000
Minimal flow rate	Q _{min}	l/h	210	600
Smallest registered value		l	0.1	0.1
Metering capacity		m ³ /h	100000	100000
Metering time at Q _n without overflow		h	28500	10000
Safety filter mesh size in meter base		mm	2.5	2.5
Housing finish		enamelled yellow RAL 1007		
Weight		kg	7.20	14.20

1) $\pm 5\%$ at lower end of measuring range between Q_{min} and Q_t.

Measuring module materials

Component	Materials
Housing	Stainless steel*
Measuring unit	Stainless steel*
Seals	PTFE
Vane wheel bearings	PTFE (90 °C), graphite (180 °C)

* Corrosion and acid-resistant steel (CrNiMo) to DIN 1.4408 / 1.44354

Pressure drop characteristics

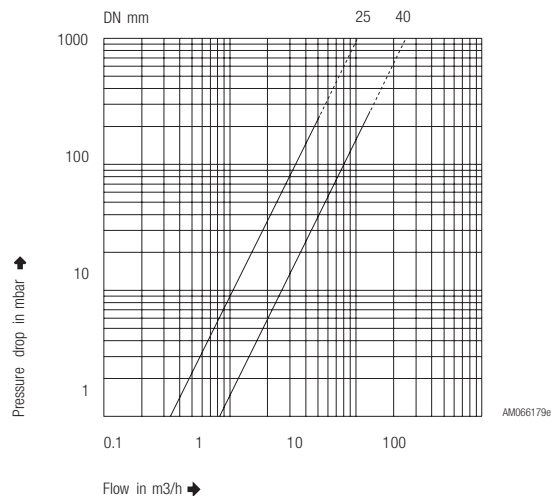

Measuring module dimensions in mm

AMD
DN 25

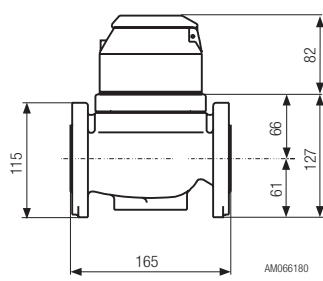
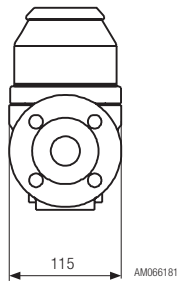

DN 40

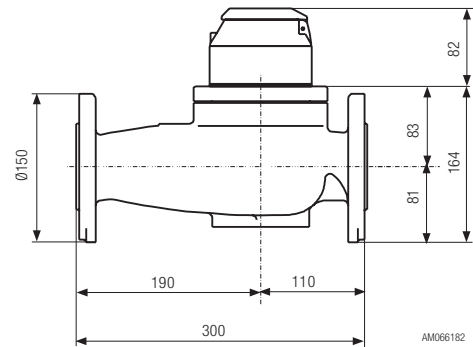
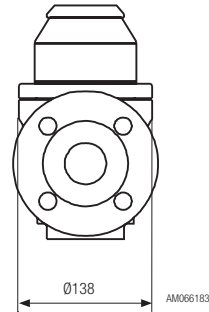

Flanges to DIN 2501 / SN 21843

Roller registers and dials

RW
roller register only
max. 180 °C

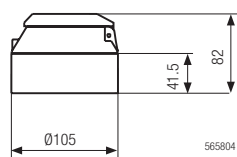

RV
with integrated pulser (reed type)
max. 180 °C

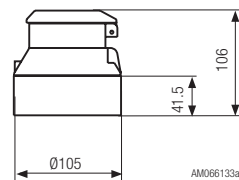

Dials
DN 25, 40

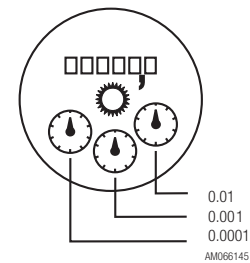

Pulsers

Technical data

For further technical data and wiring diagrammes, see sections „Pulsers“.

Pulse values

Pulser type ¹⁾	Nominal diameter of measuring unit		
		25	40
RV Reed switch	l/pulse	1	1
IN Inductive switch (NAMUR)	l/pulse	0.1	0.1
	l/pulse	1	1
INA Inductive switch (NAMUR)	approx. l/pulse	0.01032	0.03956

1) High temperature versions are designated with H.

Pulse frequencies

IN 0.1	at Qmax	Hz	13.889	33.333
	at Qmin	Hz	0.389	1.111
INA	at Qmax	Hz	134.582	84.260
	at Qmin	Hz	3.768	2.809

Pulser modules

IN inductive pulser according to IEC 60947-5-6 (NAMUR), with EC type approval or official verification.

IN
max. 130 °C

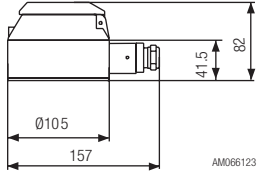

High resolution INA inductive pulser according to IEC 60947-5-6, with EC type approval II 2 G EEx ia IIC T6.

INA
max. 90 °C

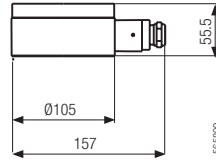

INAH
max. 180 °C

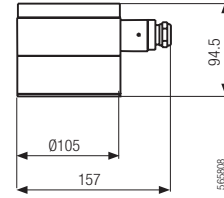

DOMINO® PMD vane wheel flowmeters

Technical data



- Primarily used for water flow measurement or dosing
- Brass housing with threaded connections or threaded flanges
- For horizontal installation - dial upward
- Measuring tolerances $\pm 2\%$ of effective value ¹⁾, repeatability $\pm 0.3\%$
- Temperature max. 90 °C
- Rated pressure 16 bar
- Available only with modules „pulsar with roller register“ or „installation for batching control“.

Nominal diameter	DN	mm	20	25	40
		inch	3/4	1	1 1/2
Overall length		mm	190	260	300
Rated pressure PN		bar	16	16	16
Max. temperature	T _{max}	°C	90	90	90
Maximum flow rate	Q _{max}	l/h	5000	7000	20000
Continuous flow rate	Q_n	l/h	2500	3500	10000
Transitional flow rate	Q _t	l/h	200	280	800
Minimal flow rate	Q _{min}	l/h	100	140	400
With AS 110 filling control:					
Transitional flow rate	Q _t	l/h	350	450	1000
Minimal flow rate	Q _{min}	l/h	250	300	600
Smallest registered value		l	0.1	0.1	0.1
Metering capacity		m ³ /h	100000	100000	100000
Metering time at Q _n without overflow		h	40000	28500	10000
Safety filter mesh size in meter base		mm	1.5	1.5	2.5
Housing thread		inch	1	1 1/4	2
Screw connection thread		inch	3/4	1	1 1/2
Housing finish		enamelled yellow RAL 1007			
Weight without screw connections		kg	3.10	4.10	6.50

1) $\pm 5\%$ at lower end of measuring range between Q_{min} and Q_t.

Measuring module materials

Component	Materials
Housing	Brass
Measuring unit	PPO plastic
Seals	EPDM (ethylene propylene)
Vane wheel bearings	Plastic and synthetic ruby balls

Pressure drop characteristics

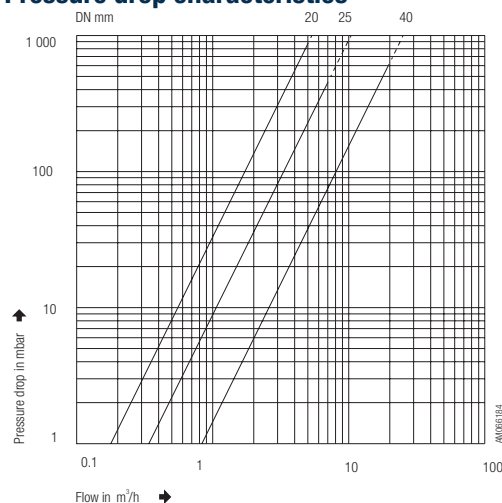

Measuring module dimensions in mm

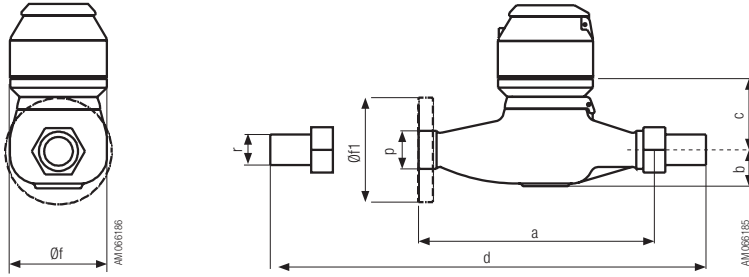

Dials

DN 20, 25, 40

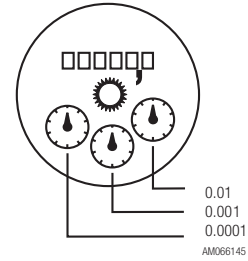

	DN	a	b	c	d	Øf	Øf1	p	r
PMD 20	20	190	37	74	285	92	105	G 1"	G 3/4"
PMD 25	25	260	40	83	375	105	115	G 1 1/4"	G 1"
PMD 40	40	300	60	91	440	139	150	G 2"	G 1 1/2"

Pulser modules

Module installation heights are given in sections "AMD modules".

Pulsers

Technical data

For further technical data and wiring diagrammes, see sections „Pulsers“.

Pulse values

Pulser type	Nominal diameter of measuring unit				
		mm	20	25	40
		inch	3/4	1	1 1/2
IN Inductive switch (NAMUR)		l/pulse	0.1	0.1	0.1
		l/pulse	1	1	1
INA Inductive switch (NAMUR)	approx.	l/pulse	0.00864	0.01434	0.04990

Pulse frequencies

IN	at Qmax	Hz	13.889	19.444	55.555
	at Qmin	Hz	0.278	0.389	1.111
INA	at Qmax	Hz	160.751	135.596	111.334
	at Qmin	Hz	3.215	2.712	2.227

Pulsers

IN: Inductive pulser with decadic pulse values INA: High-resolution inductive pulser

Pulser types IN, INA for industrial applications



IN, INA pulser module



Wiring diagramme

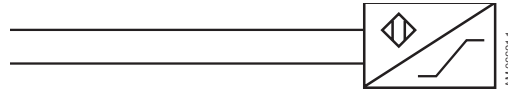

Switching element:

Switching voltage:

Residual ripple:

Switching current:

Static current:

Switch-on time:

Ambient temperature:

Protection class:

Use in explosion risk zones:

Connections:

- Slotted disc initiator according to IEC 60947-5-6
- 5...15 V DC
- max. 5 %
- > 3 mA (at 8 V DC, 1 KOhm)
- < 1 mA (at 8 V DC, 1 KOhm)
- 50 ± 10 %
- -10 ... +70 °C
- IP 65 (IEC 60529) against water-jets and dust
- Available with ATEX Certificate II 2 G EEx ia IIC T6 for use in hazardous areas
- Connect cabel (min. 2 x 0.35 mm²) to pulser probe with plug provided. Cable outer diameter 4...6 mm. For use in explosion risk zones are preferably light blue cables to be used. See local regulations for Ex risk use!

RV: Reed pulser with decadic pulse values

RV pulser for remote totalizing integrated in roller register



Wiring diagramme

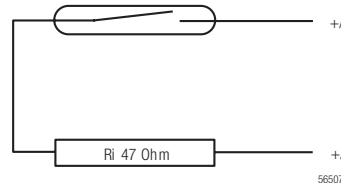

This simple version of a reed pulser is suitable for remote totalizing. For industrial control systems the IN or INA versions are recommended. Electronic pulse counters have low switching power consumption. They are therefore energized directly from the pulser. Electromechanical pulse counters with power consumption exceeding 2 W require an intermediate switching relay.

Switching element:

Switching voltage:

Switching current:

Static current:

Switching power:

Ambient temperature:

Protection class:

Connection:

- Reed contact tube filled with inert gas
- max. 48 V AC or DC
- max. 50 mA (internal resistance 47 Ohm/0.5 W)
- open contact
- max. 2 W
- -10 ... +70 °C
- IP 65 (IEC 60529) protection against water-jets and dust
- Permanent mounted grey cable, 3 m long, 2 x 0.14 mm² cross section

Ordering information

ARD sensors: Type designations and order numbers

(for standard versions; special versions on request)

ARD 1000 measuring module

Measuring chamber	Seal	Rotary piston	PN bar	T _{max} °C	Type designation	Nominal diameter				
						15	20	25	40	50
Brass housing with threaded connections										
Brass / PPS	FPM	Aluminium	16	130	ARD../1111-A2	83000	83033	83058	-	-
		Graphite	16	130	ARD../1111-G2	83002	83035	83060	-	-
		PTFE	16	40	ARD../1111-P2	83004	83036	83062	-	-
Spherulitic cast iron housing with threaded connections										
Brass / PPS	FPM	Aluminium	16	130	ARD../1211-A2	-	-	-	83106	-
		Graphite	16	130	ARD../1211-G2	-	-	-	83108	-
		PTFE	16	40	ARD../1211-P2	-	-	-	83110	-
Spherulitic cast iron housing with flanged connections										
Brass / PPS	FPM	Aluminium	25	130	ARD../1221-A2	83005	83037	83063	83111	83154
		Graphite	25	130	ARD../1221-G2	83007	83039	83065	83113	83155
Brass / PTFE	FPM	Aluminium	25	180	ARD../1222-A2	83009	83040	83067	83115	83157
		Graphite	25	180	ARD../1222-G2	83010	83041	83068	83116	83158
		PTFE	25	40	ARD../1222-P2	83011	83042	83069	83117	83159
Brass / PTFE ¹⁾	FPM	Aluminium	25	180	ARD../1223-A2	83012	83043	83070	83118	83160

1) Measuring chamber, particularly for heavy fuel oil (measuring tolerance ±1 %)

ARD 2000 measuring module

Measuring chamber	Seal	Rotary piston	PN bar	T _{max} °C	Type designation	Nominal diameter				
						15	20	25	40	50
Spherulitic cast iron housing with flanged connections										
Stainless steel / PPS	FPM	Aluminium	40	130	ARD../2224-A2	83013	83218	83071	83119	83161
		Graphite	40	130	ARD../2224-G2	83014	83219	83072	83120	83162
		Stainless steel	40	130	ARD../2224-S2	83015	83220	83073	83121	-
		PTFE	40	40	ARD../2224-P2	83017	83221	83075	83123	83165
Stainless steel / PTFE	FPM	Aluminium	40	180	ARD../2225-A2	83018	83044	83076	83124	83166
		Graphite	40	180	ARD../2225-G2	83019	83045	83077	83125	83167
		Stainless steel	40	180	ARD../2225-S2	83020	83046	83078	83126	-
		PTFE	40	40	ARD../2225-P2	83021	83047	83079	83127	83169
Stainless steel / PTFE	PTFE	Graphite	40	180	ARD../2225-G6	83022	83048	83080	83128	83170
		Stainless steel	40	180	ARD../2225-S6	83023	83049	83081	83129	-
		PTFE	40	40	ARD../2225-P6	83024	83050	83082	83130	83172

ARD 3000 measuring module

Measuring chamber	Seal	Rotary piston	PN bar	T _{max} °C	Type designation	Nominal diameter				
						15	20	25	40	50
Stainless steel (corrosion and acid-proof) housing with flanged connections										
Stainless steel / PTFE	FPM	Graphite	25	180	ARD../3315-G2	83026	83052	83096	83144	83173
		Stainless steel	25	180	ARD../3315-S2	83027	83053	83097	83145	-
		PTFE	25	40	ARD../3315-P2	83028	83054	83098	83146	83175
Stainless steel / PTFE	PTFE	Graphite	25	180	ARD../3315-G6	83029	83055	83099	83147	83176
		Stainless steel	25	180	ARD../3315-S6	83030	83056	83100	83148	-
		PTFE	25	40	ARD../3315-P6	83031	83057	83101	83149	83178

ARD 4000 measuring module

Measuring chamber	Seal	Rotary piston	PN bar	T _{max} °C	Type designation	Nominal diameter				
						15	20	25	40	50
PTFE plastic housing with flanged connections										
PTFE / Tantal	FFKM	PTFE	10	50	ARD../4467-P5	-	-	83105	83153	-

Type designation key for device identification

Example of type designation key

ARD 25 /1 22 3 /A 2 /PN

Type series	ARD	ARD							
Nominal diameter	15 mm	15							
	20 mm	20							
	25 mm	25							
	40 mm	40							
	50 mm	50							
Configuration group	/1000		1						
	/2000		2						
	/3000		3						
	/4000		4						
Housing	Threaded	Brass			11				
		Spherulitic cast iron			21				
	Flanged	Spherulitic cast iron			22				
		Stainless steel			31				
		PTFE			46				
Measuring chamber	Brass / PPS					1			
	Brass / PTFE					2			
	Brass / PTFE (1 %) ¹⁾					3			
	Stainless steel / PPS					4			
	Stainless steel / PTFE					5			
	PTFE / Tantal					7			
	Brass / PTFE (1 %) ¹⁾					8			
Rotary piston	Aluminium						A		
	Graphite						G		
	Stainless steel						S		
	PTFE						P		
Seal set	FPM Fluoroelastomer							2	
	FFKM Perfluoroelastomer							5	
	PTFE Polytetrafluoroethylene							6	
Flange drillings	DIN PN								PN 10 PN 16 PN 25 PN 40

1) Measuring chamber, particularly for heavy fuel oil measuring tolerance ± 1 %

ARD modules: Type designations and order numbers

(for standard versions; special versions on request)

Pulser module Pulse values in litres	Roller register RV Pulse values in litres	T _{max} °C	Type designation	Nominal diameter				
				15	20	25	40	50
RW module 180 °C								
		180	RW/RD ..	83500	83526	83552	83578	83604
IN module 130 °C								
0.01		130	IN 0.01/RW/RD..	83509	83535	-	-	-
0.1		130	IN 0.1/RW/RD..	83512	83538	83561	83587	-
1		130	IN 1/RW/RD..	-	-	83564	83590	83613
10		130	IN 10/RW/RD50	-	-	-	-	-
83616								
IN module 180 °C								
0.01		180	IN 0.01H/RW/RD..	83513	83539	-	-	-
0.1		180	IN 0.1H/RW/RD..	83516	83542	83565	83591	-
1		180	IN 1H/RW/RD..	-	-	83568	83594	83617
10		180	IN 10H/RW/RD50	-	-	-	-	83620
INA module 90 °C								
High-resolution 83621		90	INA/RW/RD..	83517	83543	83569	83595	
High-resolution	Sealing plate	90	INA/RD..	83520	83546	83572	83598	83624
INA module 180 °C								
High-resolution 83625		180	INAH/RW/RD..	83521	83547	83573	83599	
High-resolution	Sealing plate	180	INAH/RD..	83524	83550	83576	83602	83628
GTAS module for AS / ASP batching controls 180 °C								
		180	GTAS/RD..	83685	83686	83687	83688	83689

ATEX-modifications

96044 Modifications for ATEX devices

Pulser module Pulse values in litres	Roller register RV Pulse values in litres	T _{max} °C	Type designation	Nominal diameter				
				15	20	25	40	50
RV module 180 °C - Not available with CE-Conformity								
0.1		180	RV 0.1/RD..	83501	83695	-	-	-
1		180	RV 1/RD..	83502	83527	83553	83579	-
10		180	RV 10/RD..	-	83528	83554	83580	83605
100		180	RV 100/RD50	-	-	-	-	83606

Type designation key for device identification

Example of type designation key

IN 1H / RV 10 / RD 25

Pulser	Pulse value in litres	T _{max} °C			
None		180			
IN Inductive	0.01	130	IN 0.01		
	0.1	130	IN 0.1		
	1	130	IN 1		
	10	130	IN 10		
IN Inductive	0.01	180	IN 0.01H		
	0.1	180	IN 0.1H		
	1	180	IN 1H		
	10	180	IN 10H		
INA Inductive high-resolution		90	INA		
		180	INAH		
Module for AS / ASP filling control			GTAS		
Roller register				RW	
Roller register with integral pulser	0.1			RV 0.1	
	1			RV 1	
	10			RV 10	
	100			RV 100	
Sealing plate without roller register					
Nominal diameter of flowmeter	DN 15				RD 15
	DN 20				RD 20
	DN 25				RD 25
	DN 40				RD 40
	DN 50				RD 50
Display units	Litres				

AMD measuring modules

Housing	Measuring unit bearings	PN bar	T _{max} °C	Type designation	Nominal diameter	
					25	40
AMD 3000						
Stainless steel	Stainless steel / PTFE	16	90	AMD../3331	84002	84006
	Stainless steel / graphite	16	180	AMD../3332	84003	84007

Type designation key for device identification

Example of type designation key

AMD 25 / 3 3 3 1 / PN

Type series			AMD	AMD				
Nominal diameter	25 mm		25					
	40 mm		40					
Configuration group	/3000			3				
Housing	Stainless steel	PN 25			3			
Measuring unit	Stainless steel					3		
Bearings	PTFE	90 °C					1	
	Graphite	180 °C					2	
Flange drillings	DIN PN	PN 16 / 25						PN 16 PN 25

AMD modules: Type designations and order numbers

(for standard versions)

Pulser module Pulse values in litres	Roller register RV Pulse values in litres	T _{max} °C	Type designation	Nominal diameter 25	40
RW module					
		180	RW/MD ..	84010	84016
RV module					
		180	RV 1/MD ..	84040	84041
IN module					
0.1		130	IN 0.1/RW/MD..	84012	84018
1		130	IN 1/RW/MD..	84013	84019
0.1		180	IN 0.1H/RW/MD..	on request	on request
1		180	IN 1H/RW/MD..	on request	on request
INA module					
High-resolution	Sealing plate	90	INA/MD..	84015	84021
High-resolution		180	INAH/MD..	on request	on request
GTAS module for AS / ASP filling controls					
		180	GTAS/MD	84014	84020

ATEX-modifications

96044 Modifications for ATEX devices

Example of type designation key

IN 1

/ RW

/ MD 25

Pulser	Pulse value in litres	T _{max} °C			
None					
IN Inductive	0.1	130	IN 0.1		
	1	130	IN 1		
INA Inductive high-resolution		90	INA		
		180	INAH		
Module for AS / ASP filling control			GTAS		
Roller register		180		RW	
Roller register with integral pulser	1			RV 1	
Nominal diameter of flowmeter	DN 25				MD 25
	DN 40				MD 40
Display units	Litres				

Complete PMD flowmeters

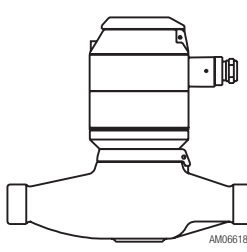
	Type designation	Version	Order No.
	PMD 20 - IN 0.1	with inductive pulser IN 0.1 l	84023
	PMD 20 - IN 1	with inductive pulser IN 1 l	84024
	PMD 20 - INA	with high-resolution pulser	on request
	PMD 20 + adapter	prepared for batching control system	84025
	PMD 25 - IN 0.1	with inductive pulser IN 0.1 l	84027
	PMD 25 - IN 1	with inductive pulser IN 1 l	84028
	PMD 25 - INA	with high-resolution pulser	on request
	PMD 25 + adapter	prepared for batching control system	84029
	PMD 40 - IN 0.1	with inductive pulser IN 0.1 l	84035
	PMD 40 - IN 1	with inductive pulser IN 1 l	84036
	PMD 40 - INA	with high-resolution pulser	on request
	PMD 40 + adapter	prepared for batching control system	84037

ATEX-modifications

96044 Modifications for ATEX devices

Accreditations

ATEX Directive

With the exception of the - RV ... - ancillary groups, all DOMINO® components are certified according to ATEX Directive.

Marking:  II2G cT6

Pressure Equipment Directive PED

In accordance with the guidelines, a CE or supplier conformity declaration are available on our website for all DOMINO® devices.